

**RT55SM (latch & door)**  
**55 LBS THRUST**  
**12 VOLT 50 AMPS**  
**52" SHAFT**

**for use with "AH" serial numbers**  
**3-year warranty from the date of purchase**

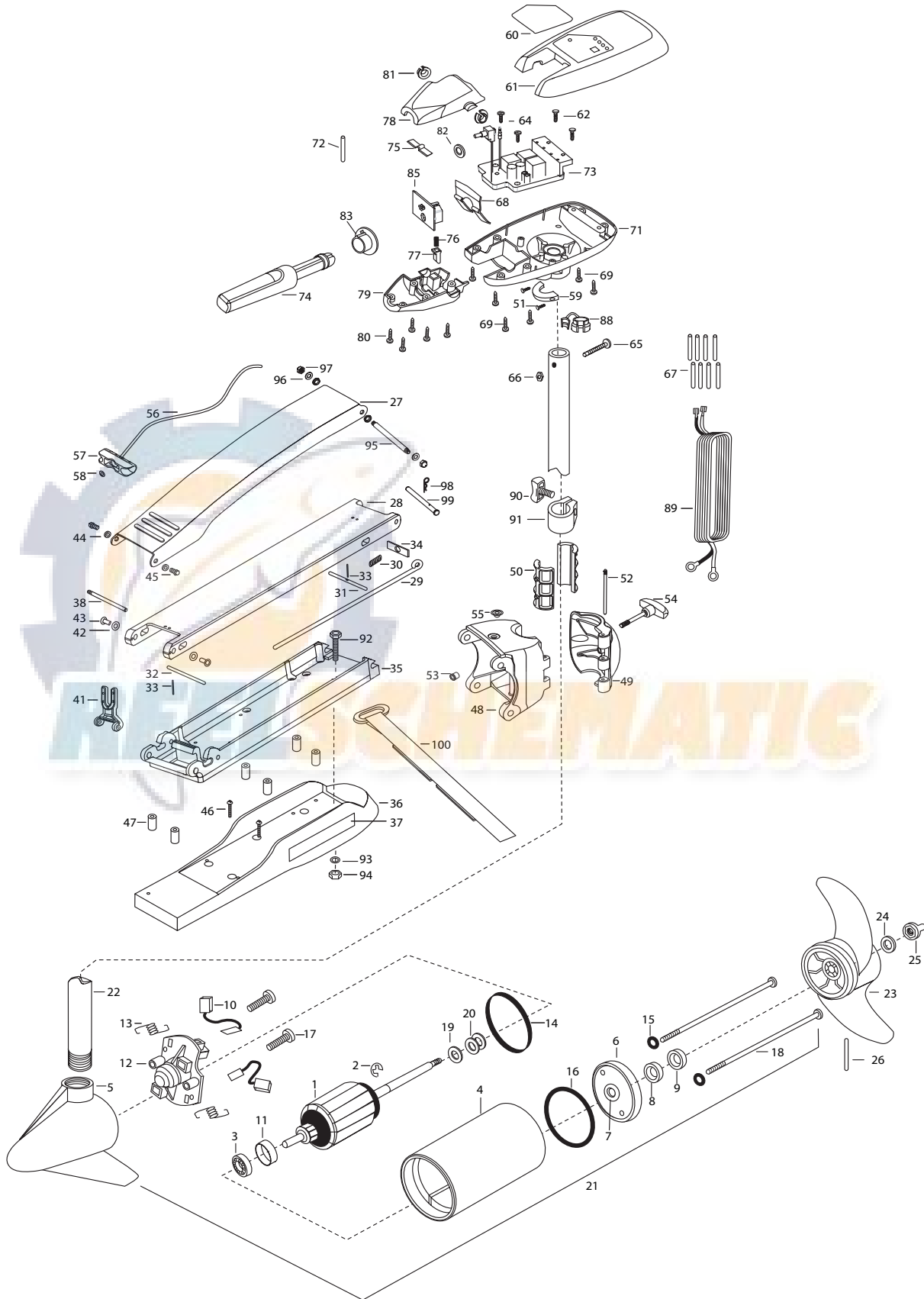

1	92-100-115	ARMATURE ASSEMBLY12V 3.625	32	2233623	LOCK BAR, REAR S/S	68	2302743	SPRING-DETENT -HANDLE-TILT
2	788-015	RETAINING RING	33	2152612	SPRING-PIN (LOCKBAR) [2. EA]	69	2303412	SCREW-6-20 X 5/8 SELF TAP [6. EA]
3	140-010	BEARING -BALL	34	2262703	SPRING STOP	71	2062596	CONTROL BOX, SW, .725 BORE WHT
4	2-200-301	CENTER HOUSING ASSEMBLY 3.625 WHT	35	2993983	BOWPLATE/INSRT ASSEMBLY,STD,SW	72	2305410	SHRINK TUBING
5	421-336	HOUSING- BRUSH END 3.625 SW WHI	36	2263914	MOTOR REST STD MAXXUM WHT	73	2184000	CONTROL BOARD ASSEMBLY
6	2-400-337	PLAIN END HOUSING ASSEMBLY 3.625	37	2065677	DECAL-MOTOR REST RT/W [2. EA]	74	2990915	HANDLE ASSEMBLY W/O U-JOINT
7	144-049	BEARING - FLANGE [SERVICE ONLY]	38	2260505	PIN-HINGE (HEADLESS) S/S	75	2302742	SPRING-DETENT(OFF) SS
8	880-003	SEAL	41	2293811	YOKE,MAX MNT-POLYPROPYLENE	76	2302745	SPRING-RELEASE BUTTON SS
9	880-006	SEAL WITH SHIELD	42	2261708	WASHER-3/8X1/2X.016 (SS) [2. EA]	77	2303720	RELEASE BUTTON-HANDLE
10	188-036	BRUSH ASSEMBLY [2. EA]	43	2236000	BEARING NYLINER [2. EA]	78	2060411	HANDLE (TOP HALF)
11	725-050	PAPER TUBE- BRUSH RETENTION	44	2293501	BUSHING, STAINLESS STEEL [4. EA]	79	2060415	HANDLE (LOWER HALF)
12	738-036	BRUSH PLATE W/HOLDER 3.625	45	2263500	BOLT, SHOULDER [2. EA]	80	2303412	SCREW-6-20 X 5/8 SELF TAP [5. EA]
13	975-040	SPRING - TORSION [2.EA]	46	2263434	SCREW, #8 X 1" PPH SS [2. EA]	81	2060005	BEARING-HANDLE PIVOT [2. EA]
14	337-036	GASKET	47	2261505	SPACER, MOTOR REST [6. EA]	82	2181700	WASHER SPACER
15	701-008	O-RING [2. EA]	48	2261863	HINGE BASE/INSERT ASSEMBLY,SW,	83	2992852	ACTUATOR-CAM
16	701-081	O-RING	49	2261859	HINGE DOOR STD WHT TEX	85	2184020	POT ADAPTER
17	830-007	SCREW # 8-32 [2.EA]	50	2151532	HINGE-SLEEVE HALF-AT [2. EA]	88	2332900	STRAIN RELIEF-C.CORD/SP.C
18	830-042	THRU BOLT 10-32 X 8.83 [2. EA]	51	2263434	SCREW- #8 X 1" PPH SS [2.EA]	89	2090650	LEADWIRE (10 GA-4) (RINGS)
19	990-067	WASHER - STEEL THRUST	52	2262642	PIN-HINGE DOOR, RT HNG,	90	2011366	SCREW-COLLAR/NEW KNOB (SS)
20	990-070	WASHER - NYLATRON [2. EA]	53	2264706	INSERT-HINGE BASE (STD MT)	91	2031520	COLLAR-DEPTH (W/O INSERT)
21	2097095	MOTOR- ASSEMBLY 12V 3.62 SW VARS	54	2260902	KNOB-HINGE COVER SW S/S	■	2994830	BAG ASSEMBLY
22	2032034	TUBE COMPOSITE 52" WHT	55	2232315	EYELET-ROPE STAINLESS STEEL	*92	2263431	SCREW 1/4-20 X 3.5 PPH [6. EA]
■	1378131	PROPELLER KIT	56	2251601	ROPE (40"),	*93	2261713	WASHER-1/4 FLAT S/S [6. EA]
23	2091160	PROPELLER (W.WEDGE 2)	57	2150400	PULL-GRIP	*94	2263103	NUT-1/4-20 NYLOCK-JAM S/S [6. EA]
24	2151726	WASHER- 5/16 STD	58	2151700	WASHER-EYE SHAFT(.562 OD)	95	2262604	PIN UPPER
25	2198400	ANODE-ZINC 3.25/3.625 LWR U	59	2061517	COLLAR-CTRL BOX SW WHT	96	2261722	WASHER FLAT 5/16" SS [2 EA.]
26	2092600	PIN-DRIVE	60	2095681	DECAL-COVER, RT55/B HC	97	2223100	NUT TENSION 5/16-18" SS [2 EA.]
■	2991845	MOUNT,BOW ASSEMBLY,SW STD HNGD	61	2300219	COVER- CONTROL BOX RIPTIDE WHT	98	2260806	CLIP HAIR SPRING SS
27	2264244	ARM-UPPER STD SW TXT WHT	62	2301310	SCREW-8-18 X 1/2 SS [2. EA]	99	2262606	PIN LOWER
28	2994310	ARM-LOWER ASY STD WHT SW	64	2372100	SCREW-8-18 X 5/8 THD (SS) [2. EA]	100	2263408	VELCRO STRAP
29	2153603	EYE SHAFT-2 LOCKBAR STD SS	65	2263406	SCREW-10-24 X 2" SS PPH			
30	2152701	SPRING-(LOCKBAR) SS	66	2333101	NUT-HEX 10-24 UNC-2B NYLOC			
31	2233621	LOCKBAR (SS) (NEW 500)	67	2305401	SHRINK TUBE-3/8 OD X 1-1 [4. EA]			

# RT55SM is 12-volt!

